



Harmony of form and function

Touchscreens for a new era

High environmental durability and compatibility
Extensive functions that make devices IoT-compatible



Stylish glass top melds form and function

7.0 inch Wide
Actual Size

128mm

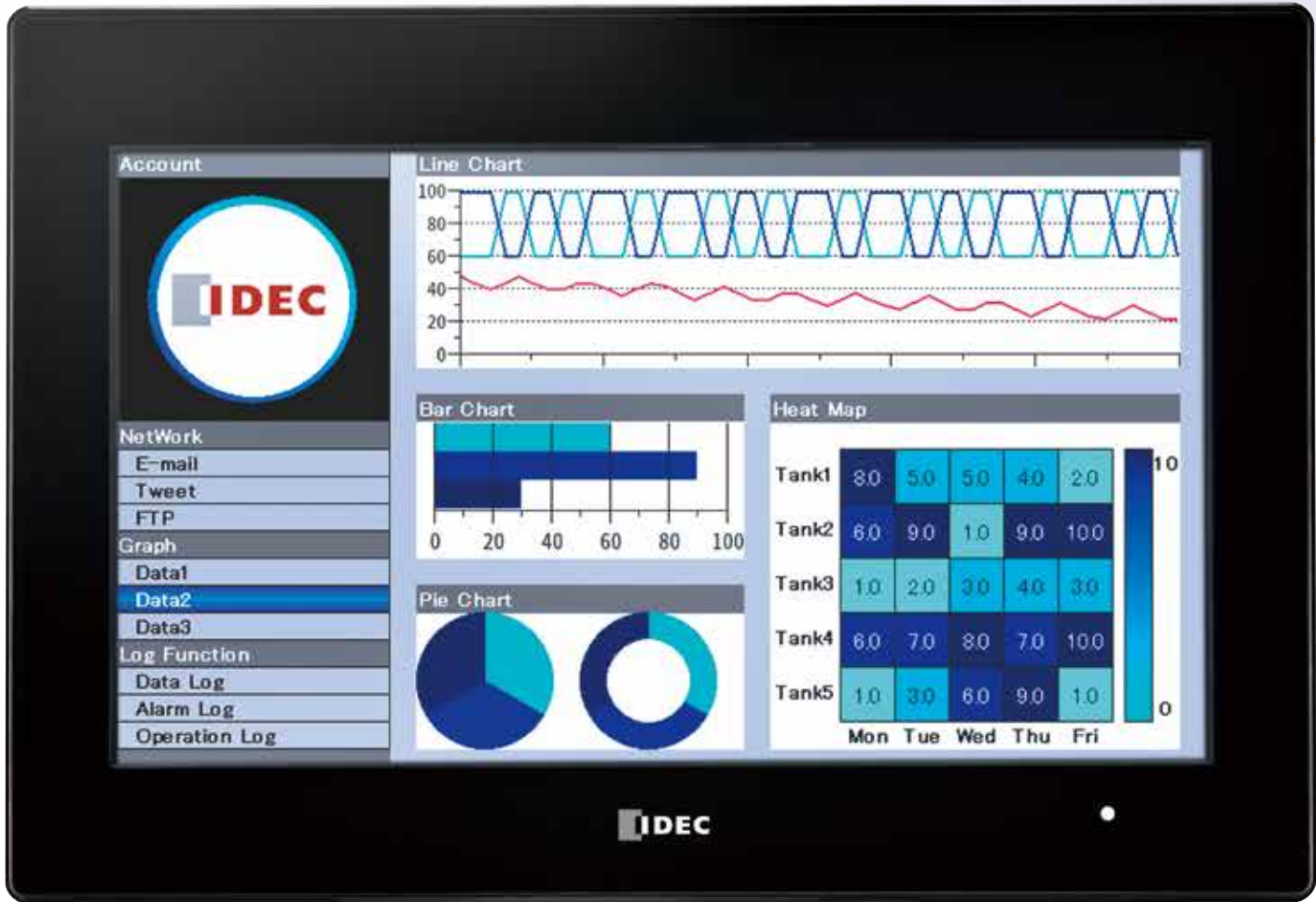

186mm



Innovative glass top

A glass-covered touchscreen design offers users a high degree of visibility and clarity.





Large screen, slim bezel design

Reductions in bezel width achieve a slim design without sacrificing screen size. In fact, these 7.0 inch screens can fit in the same space as a conventional 5.7 inch product.

Though optimal selection and arrangement of parts on a single circuit board, this slim panel board maintains an inner depth of just 29mm, enabling downsizing of the control panel.

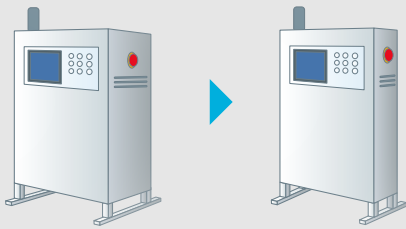

HG2J 7.0 inches wide

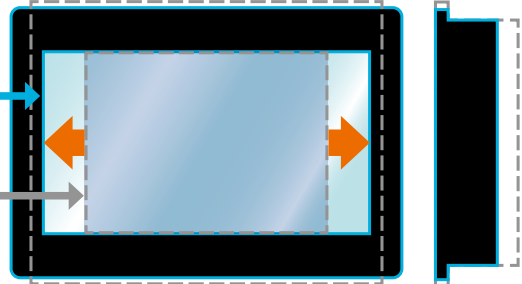

Conventional product: 5.7 inches

- Screen resolution: Approx. **5.0x**
- Display area : Approx. **1.35x**
- Board area : Approx. **1.06x**
- Depth : Approx. **0.68x** (*1)

*1) Compared to conventional HG2G-5T.



Glass-top structure offers excellent hygienic characteristics

Touch surface is scratch resistant, waterproof, and oil resistant to keep it stain-free. It can also be sprayed with antiseptic solutions or wiped with a towelette soaked in concentrated chemicals like alcohol.

- See website for details on disinfection methods and the effect that antiseptic solutions will have on the product.



Projected capacitive (PCAP) touchscreen

Conventional analog resistive film touchscreens often have mechanical durability issues, as they determine position through contact with a transparent electrode film. PCAP touchscreens determine position by detecting changes in electrical charge with a sensor board. They have no mechanical durability issues and are capable of both nimble operation and two-point touch operation. Additionally, they prevent accidental input due to water droplets and are operable with gloves under 1.5mm in thickness (*2).

- *2) Even with gloves under 1.5mm, there may be issues with operability depending on the glove material and the operating environment. Check operation in the actual environment or under similar conditions.

PCAP touchscreen

No mechanical durability issues

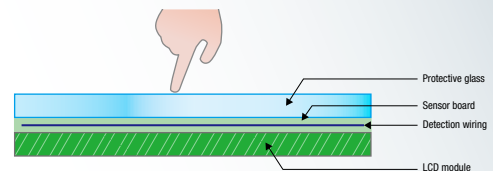

Analog resistive touchscreen

Mechanical durability issues

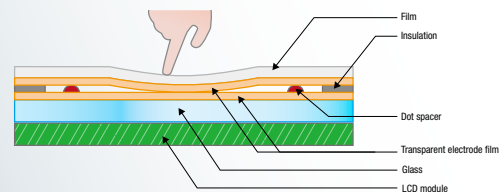

Excellent environmental durability for a wide variety of applications

Wide range of operating temperatures

Suitable for use in temperatures ranging from -20 to 60°C (*1) and for devices used in hot and cold environments.

*1) No freezing.



High water resistance

With an IPX6F/IPX7 degree of protection, powerful water jets can be used.



Retains its clarity for years

Products with a surface film will grow cloudy over time, reducing visibility. By using a glass-covered touchscreen, the screen can maintain a high degree of visibility over time, as the glass keeps it from deteriorating and growing cloudy due to UV rays.

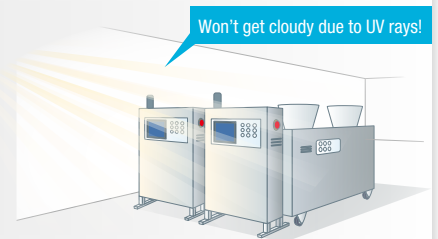

Advanced connectability

Extensive external interfaces

RS232C, RS422/485, Ethernet, and USB-A communication interface ports enable easy connection to external peripherals like PLCs and barcode readers. Additionally, a safe and simple push-in terminal is used for serial interfaces and power terminals, enabling one step wiring.

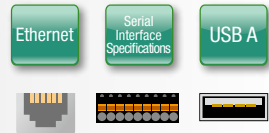

Easily connected to generic USB peripherals (*2)

Connecting a USB speaker to the USB-A port enables speech output.



The conveyor belt has stopped.

Connecting a general-purpose Wi-Fi dongle to the USB-A port enables wireless communication with PC and tablets.



Installation example

With the touchscreen installed, speech output can be used to notify nearby workers of the status of machinery. The worker does not need to stop what they are doing to check the status, so work efficiency improves.

*2) Only specific general-purpose USB peripherals verified by IDEC are usable. See website for details.

Makes devices IoT-compatible

Web server function enables remote operation and maintenance from tablets

The Operator Interface can be checked and operated from standard web browsers on tablets and PCs. No special software required. Furthermore, the custom web page function allows the browser to display an interface that differs from the one displayed on the operator interface.



Installation example

Moving between each device to check its status and operate it in a facility where multiple devices are installed over a wide area, like a distribution warehouse, can take an incredible amount of time and effort. The web server function allows you to check the status of devices and operate them from a tablet, eliminating the need to move to the device.

Ideal for remote area installation Battery-free design eliminates the need for a battery-replacement

Data is stored on nonvolatile magnetic media and time information is preserved with power from large-capacity capacitors, requiring no batteries. No need for troublesome paperwork when sending products with batteries overseas.

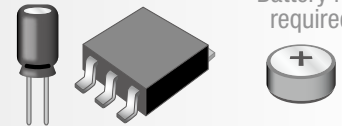

Battery not required



FTP client function enables transfer of log data

Log data can actively be transferred to the file server from the operator interface in the form of a CSV using the FTP client function. Additionally, the operator interface can fetch data from remote PCs using the FTP server function.



SNS function, E-mail function

Status of a device can be sent by email and to multiple Twitter accounts.



Installation example

Quickly checking the status of widely dispersed devices, such as bicycle parking lots and coin-operated parking lots, has been difficult due to the need for a custom web system or other requirement. Using the Tweet function makes it possible to collectively check the status of a number of devices from Twitter by having each one Tweet its status.

*1) Available in Automation Organizer.

Check information of the object at a glance

Information such as device address and operating condition of parts laid out on the screen can be checked easily. During monitoring, device address values will pop up, and parts that have conditions met will be distinguishable through color.



User communication function enables compatibility with custom protocols

Send and receive commands can be created to work with custom protocols or protocols that are not supported by default to communicate with devices.

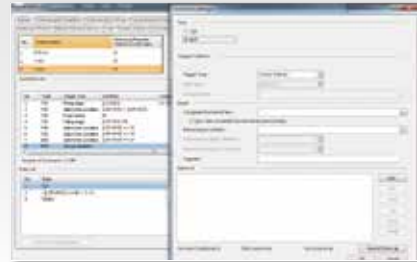

Error log helps specify problems of the project easily

The error check function displays incorrect setup or missed items in a list. Errors can be directly checked from this list so problems can be solved quickly even in a large project.



Scripting function makes programming easy even for difficult processes

The scripting function makes programming for difficult processes, such as conditional branching, logical and mathematical operations and functions, easy. Furthermore, using the script debugger to check the operation of the script step by step during simulation mode will increase efficiency.

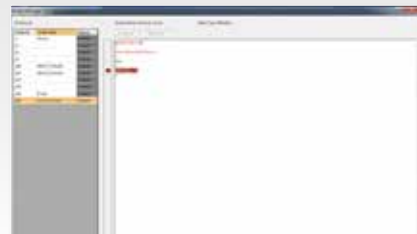

Extensive image library

Drag & drop functionality allows for the intuitive laying out of parts represented by beautiful images. Additionally, over 10,000 images can be imported from tools and used in parts.



Frequently used part configurations are easily managed with the parts library

Registering part configuration in the part library's custom library beforehand allows reuse of a part by dragging and dropping it in the Edit screen. There will be no need to reconfigure the part from scratch and efficiency will increase.



HG2J Operator Interface

7-inch wide

Beautiful and brilliant display with new function.
Space-saving design contributes to the downsizing of equipment.

Bright 500 cd/m ²	TFT 65,536 colors	LED 50,000 hours	48-level Brightness Adjustment	Real Parts
Outlined font	WVGA 800 x 480	Serial Interface	Ethernet	USB A 2 ports
USB Memory	User Memory 24MB	Front Panel Maintenance	Operating voltage 12/24V DC	Operating temperature -20 to +60°C

Portrait

Bezel color
Black

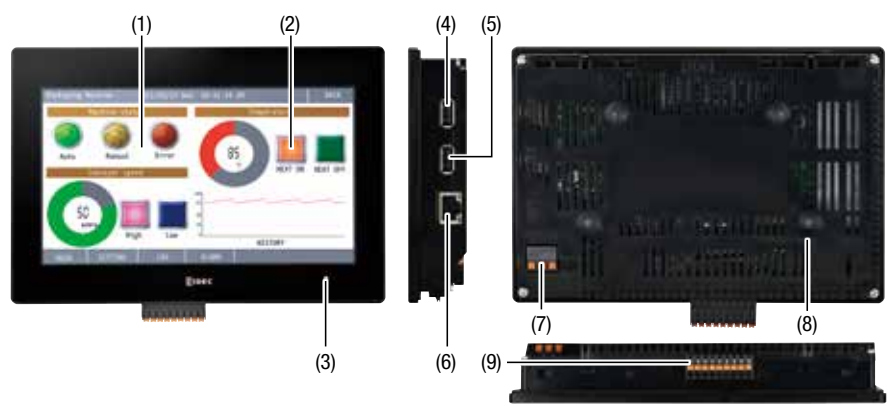

No.	Name
(1)	Display
(2)	Touchscreen
(3)	POWER LED
(4)	USB Interface (USB1)
(5)	USB Interface (USB2)

No.	Name
(6)	Ethernet Interface (LAN)
(7)	Power supply terminal
(8)	RESET Switch
(9)	Serial Interface (COM)

HG2J

Main Unit

Package Quantity: 1

Display Screen	Operation Style	Communication Interface	Bezel color	Part No.	Approvals
7-inch wide TFT color LCD 65,536 colors	PCAP touchscreen (Projected capacitive)	COM LAN USB1 USB2	Black	HG2J-7UT22TF-B	UL61010-1 UL61010-2-201 UL121201 CSA C22.2 No.61010-1 CSA C22.2 No.61010-2-201 CSA C22.2 No.213

Dimensions

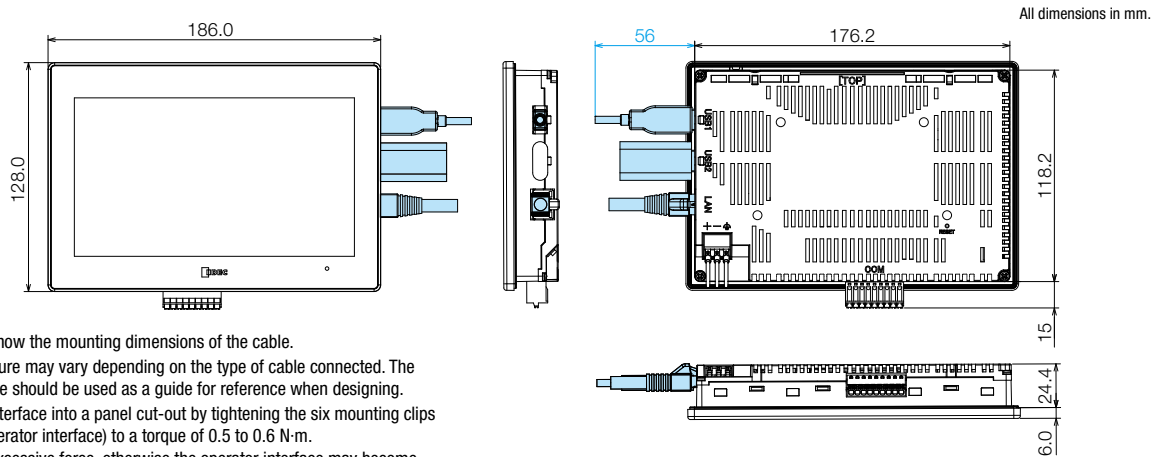

- Dimensions in blue show the mounting dimensions of the cable.
- Dimensions in the figure may vary depending on the type of cable connected. The information listed here should be used as a guide for reference when designing.
- Install the operator interface into a panel cut-out by tightening the six mounting clips (supplied with the operator interface) to a torque of 0.5 to 0.6 N·m. Do not tighten with excessive force, otherwise the operator interface may become distorted. Also, waterproof characteristics may be lost.

Panel Cut-out

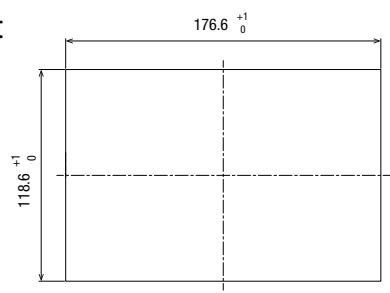

• Panel Thickness: 1.0 to 5.0mm

General Specifications

Rated Power Voltage	12/24V DC
Power Voltage Range	10.2 to 28.8V DC
Power Consumption	13W maximum
	5W maximum when not using USB1 or USB2
	3W maximum when Backlight OFF
Allowable Momentary Power Interruption	10ms max. (power supply voltage 20.4 to 28.8V DC) 1ms max. (power supply voltage 10.2 to 20.4V DC)
Inrush Current	40A maximum
Dielectric Strength	500V AC, 10 mA, 1 minute between power and FG terminals
Operating Temperature	-20 to +60°C (no freezing)
Operating Humidity	10 to 90%RH (no condensation)
Storage Temperature	-20 to +70°C (no freezing)
Storage Humidity	10 to 90%RH (no condensation)
Pollution Degree	2
Vibration Resistance	5 to 8.4 Hz single amplitude 3.5 mm, 8.4 to 150 Hz acceleration, 9.8M/s ² on each of three mutually perpendicular axes (IEC61131-2)
Shock Resistance	147m/s ² , 11ms, 5 shocks on each of three mutually perpendicular axes (IEC61131-2)
Noise Immunity	Fast transient/burst test
	Power terminals: 2 kV Communication line: 1kV (IEC/EN61131-2)
Electrostatic Discharge	Contact: 6 kV Air: 8kV (IEC/EN61131-2)
Corrosion Immunity	Free from corrosive gases
Mounting	Panel mount (panel thickness: 1.0 to 5.0 mm)
Degree of Protection	When panel thickness is less than 1 to 5mm: IP65F (IEC60529)
	When panel thickness is less than 1.6 to 5mm: IP66F, IP67F (IEC60529) TYPE 4X, TYPE 13
Dimensions	186 (W) x 128 (H) mm x 30.4 (D) mm
Weight (approx.)	500g

- Do not use the HG2J in an environment subject to strong ultraviolet rays, otherwise the LCD quality will deteriorate.

Display Specifications

Display	TFT color LCD (TN type)	
Color / Shade	65,536 colors (16-bit color)	
Effective Display Area	154.08 (W) x 85.92 (H) mm	
Display Resolution	800 (W) x 480 (H) pixels	
DPI	0.1926 (W) x 0.179 (H) mm	
View angle	Left/right/top: 80°, bottom 60°	
Backlight	White LED	
Backlight Life	50,000 hours minimum (* 1)	
Brightness	500 cd/m ² (Typ.) (*2)	
Brightness Adjustment	48 levels	
Backlight Replacement	Not replaceable by user (must be replaced by IDEC)	
Font	Shift_JIS (Japanese)	ANSI1250 (Central European language)
	ISO8859-1 (European)	European language)
	GB2312 (Simplified Chinese)	ANSI1251 (Baltic)
	BIG5 (Traditional Chinese)	ANSI1251 (Cyrillic)
	KSC5601 (Korean)	ASCII (7-seg)
Character Size	8 to 512	
Character Attribute	Blink (1 or 0.5 sec period), reverse	
Graphics	Straight line, polyline, rectangle, circle, arc, circle/ellipse, equilateral polygons (3, 4, 5, 6, 8) picture	
Window Display	3 popup screens + 1 system screen	

- *1) The backlight life is not guaranteed and refers to the time until the brightness reduces by half after use at 25°C. The actual life depends on operating environments and conditions.
- *2) Brightness of the LCD alone at an ambient temperature of 25°C.

Operation Specifications

Switching Element	PCAP (Projected capacitance) method
Multiple Operations	Up to 2 points
Acknowledgement Sound	Electronic buzzer or audio output

Function Specifications

Screen Types	Base screen, popup screen, system screen
No. of Screens	Base screen: 3,000 max. Popup screen: 3,015 max.
User Memory	Approx. 24MB
Parts	Bit Button, Word Button, Goto Screen, Print Button, Key Button, Multi Button, Keypad, Numerical Input, Character Input, Pilot Lamp, Multi-State Lamp, Picture Display, Message Display, Message Switching Display, Alarm List Display, Alarm Log Display, Data Log Display, Numerical Display, Bar Graph, Trend Chart, Pie Chart, Meter, Calendar, Bit Write Command, Word Write Command, Goto Screen Command, Print Command, Timer, Screen Script Command, Multi Command
Calendar	Year, Month, Day, Hour, Min., Sec., Day of Week±90 sec per month (at 25°C)
Power Failure Backup Data	Calendar, log data, keep relay, internal register
Backup Time	20 days (Typ.) (*3)

- *3) If the power is cut off for more than 20 days, the error message "Backup data lost" will be displayed at the next start-up and the clock data will be initialized to "00:00:00 January 1, 2000".

Interface Specifications

Serial Interface (COM) (*4)	RS232C	Electrical Characteristics	EIA RS232C compliant
		Transmission Speed	1,200 / 2,400 / 4,800 / 9,600 / 19,200 / 38,400 / 57,600 / 115,200 / 187,500bps (*5)
		Synchronization	Asynchronous
		Communication Method	Half or full duplex
		Control System	Hardware control or none
	RS422/485	Electrical Characteristics	EIA RS422/485 compliant
		Transmission Speed	1,200 / 2,400 / 4,800 / 9,600 / 19,200 / 38,400 / 57,600 / 115,200 / 187,500bps (*5)
		Synchronization	Asynchronous
		Communication Method	Half or full duplex
		Control System	None
Connector		Detachable 9-pin terminal block	
Ethernet Interface (LAN)	Interface	IEEE802.3u (10BASE-T/100BASE-TX) compliant	
	Connector	Modular connector (RJ-45)	
USB Interface (USB1) (*6)	Interface	USB2.0 High speed (480Mbps)	
	Connector	USB Type A connector	
USB Interface (USB2) (*6)	Interface	USB2.0 High speed (480Mbps)	
	Connector	USB Type A connector	

- *4) RS232C and RS422/485 can be used simultaneously.
- *5) 187,500 bps is available only with , SIEMENS SIMATIC S7-300/400 series (MPI port direct connection).
- *6) USB output current varies depending on the mounting direction and operating temperature.

Serial Interface Connector Terminal Arrangement

Name	I/O	Function	Communication
SD	OUT	Send data	RS232C
RD	IN	Receive data	
RS	OUT	Request to send	
CS	IN	Clear to send	
SG	-	Signal ground	RS232C, RS422/485
SDA	OUT	Send data "+"	RS422/485
SDB	OUT	Send data "-"	
RDA	IN	Send data "+"	
RDB	IN	Send data "-"	

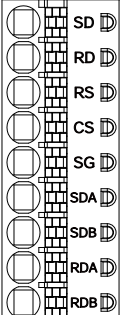

Optional (sold separately)

Name / Shape		Part No.	Package Quantity	Description	
System integration software		SW1A-W1C	1	Automation Organizer (Includes application software WindO/I-NV4)	
Protective film		HG9Z-2D7PN05	5	For 7-inch wide, used to protect the LCD 5 pcs/pack	
(Dimensions: 182.4 x 124.4 mm, sheet thickness: 0.153 mm)					
USB relay port		CW1X-USB20-1M	1	Bezel color	Cable length: 1m USB2.0 TypeA
		CW4X-USB20-1M		Bezel color: Metallic	
RJ45 relay port		CW1X-RJ45	1	Bezel color	Number of Contacts: 8pin
		CW4X-RJ45		Bezel color: Metallic	
Rubber cap (*1)		CW9Z-D1X1	1	Material : TPE Color: Black Degree of Protection: IP65/67	
Plastic cover (*1)		CW9Z-D1X2	1	Material :<Lens> Polycarbonate resin <Main body>: Polyamide resin <Gasket>: NBR Color : Translucent Degree of Protection: IP65/67	

*1) This accessory is for CW series relay ports (CW1X/CW4X) only. This product cannot be used for other models.
For details on how to use the product, refer to the instruction manual from the QR code on the right.

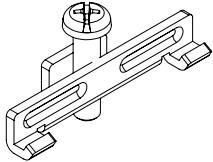
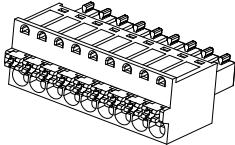

Maintenance parts (sold separately)

Name	Part No.	Package Quantity	Description
Mounting clip 	HG9Z-4K2PN04	4	Four clips are supplied.
Serial interface connector (Detachable 9-pin terminal block, Push-in terminal) 	HG9Z-XT09P	1	One connector is supplied.

Compatible PLCs

Manufacturer	Series
IDEC	MICROSmart FC6A
	SmartAXIS FT1A Pro/Lite
	MICROSmart FC6A (Ethernet)
	SmartAXIS FT1A Pro/Lite (Ethernet)
Mitsubishi	MELSEC-A (link unit)
	MELSEC-QnA (link unit)
	MELSEC-Q (link unit)
	MELSEC-Q (Ethernet)
	MELSEC-FX
OMRON	SYSMAC-C
	SYSMAC-CS
	SYSMAC-CJ1
	SYSMAC-CJ2
	SYSMAC-CP1
	SYSMAC (Ethernet)
Allen-Bradley	PLC-5 (Half Duplex)
	SLC-500 (Half Duplex)
	MicroLogix (Full Duplex)
	ControlLogix (Full Duplex)
	CompactLogix (Full Duplex)
	FlexLogix (Full Duplex)
	ControlLogix (Ethernet/IP, Ethernet/IP (Logix Native Tag))
	CompactLogix (Ethernet/IP, Ethernet/IP (Logix Native Tag))
	PLC-5 (Ethernet/IP)
	SLC 500 (Ethernet/IP)
	MicroLogix (Ethernet/IP)

Manufacturer	Series
SIEMENS	S7-200
	S7-300 (connect to CPU unit)
	S7-300 (link unit)
	S7-400
	S7-1200 (Ethernet)
Keyence	KV-700 / 1000 / 3000 / 5000
	KV Nano
	KZ
	KV
	KV (Ethernet)
Shibaura Machinery	TC200
	TCmini
Modicon	Modbus RTU Master (*1)
	Modbus RTU Slave (*2)
	Modbus ASCII Master (*1)
	Modbus TCP Client (*1)
	Modbus TCP Slave (*2)

- The compatible PLC information is for reference only (except for IDEC PLCs), and IDEC does not guarantee the operation of any other manufacturers' PLC. When using other manufacturers' PLCs, read their specifications and instruction manual carefully. The PLC must be operated correctly under the user's responsibility.
- The company names and product names are registered trademarks or brand names.
- 1) HG2J is connected as a master.
- *2) HG2J is connected as a slave.

An updated listing of compatible PLCs can be found from the following website.
 URL: <https://product.idec.com/HG>

Instructions

Read the instruction manual carefully before performing installation, wiring, maintenance, and inspection work, and before operating this product. Be sure to use the product correctly.

For details on mounting methods, wiring, and maintenance, see the instruction manual from the following URL

URL:<https://product.idec.com/?product=HG2J-7U>



- This product has been manufactured under strict quality control. However, if you intend to use this product in applications where failure of this equipment may result in damage to property or injury, ensure that it is used in conjunction with appropriate fail-safe backup equipment.
- Turn off the power to the product before starting installation, removal, wiring, maintenance, and inspection of the products. Otherwise, there will be a risk of electric shock or fire as well as damage to the equipment.
- Emergency and interlocking circuits must be configured outside of the HG2J.
- Do not use touch switches and the function keys for an emergency circuit or an interlocking circuit. If the HG2J fails, external equipment connected to the HG series will no longer be protected, and serious injury to operators and equipment damage may be caused.
- Use the product within the environmental limits given in the catalog and manual. Use of the product in high-temperature or high-humidity environments, or in locations where it is exposed to condensation, corrosive gas or large shock loads, can create the risk of electrical shock or fire.
- The HG2J is designed for use in pollution degree 2. Use the HG2J in environments of pollution degree 2. (based on the IEC60664-1 rating)
- Install the HG series according to the instructions in the User's Manual. Improper installation will result in falling, failure, electrical shock, fire hazard, or malfunction of the HG series.
- Use a power supply of the rated value. Using an incorrect power supply may cause fire.
- The HG2J uses "PS2" as DC power supply. (based on the IEC / EN61131 rating)
- Use an IEC 60127 approved fuse on the power line outside the HG2J. (Applicable when the equipment with built-in operator interface is exported to Europe.)
- When exporting the HG2J to Europe, use an EU-approved circuit protector. (Applicable when the equipment embedded with the operator interface is shipped to Europe.)
- The touch panel built-in the HG2J is made of glass. The touch panel will break if exposed to excessive shock. Be careful when handling the HG2J.
- The protective film affixed on the display of the HG2J is used to protect the product from scratches during transportation. Remove the protective film before use. If the protective film is not removed, depending on the operating environment, the film may become cloudy and adhere to the display part, making it difficult to remove.
- Do not press or scratch the touch panel and protection sheet with a hard object such as a tool.
- Do not install the HG2J in areas subject to strong ultraviolet rays, as ultraviolet rays may impair the quality of the LCD.
- Note that small black and bright dots may show up on LCD Screen. This is not a failure or malfunction.
- The backlight life is not guaranteed and refers to the time until the brightness reduces by half after use at 25°C from the initial value. The actual life depends on operating environments and conditions.
- Protection degree refers to the front of the surface after mounting. Although the protection structure satisfies various testing conditions, operation is not guaranteed under certain environments. IP66F/IP67F oilproof structure satisfies oilproof test conditions. Conditions are listed in the appendix of Japanese Industrial Standard JIS C 0920. Operation is not guaranteed when using oil for a long period of time or oil that does not satisfy standards. Please test/check before use.
- Do not attempt to disassemble, repair or modify the product. This can create the risk of fire or electrical shock.

Ordering Terms and Conditions

Thank you for using IDEC Products.

By purchasing products listed in our catalogs, datasheets, and the like (hereinafter referred to as "Catalogs") you agree to be bound by these terms and conditions. Please read and agree to the terms and conditions before placing your order.

1. Notes on contents of Catalogs

- (1) Rated values, performance values, and specification values of IDEC products listed in this Catalog are values acquired under respective conditions in independent testing, and do not guarantee values gained in combined conditions.
Also, durability varies depending on the usage environment and usage conditions.
- (2) Reference data and reference values listed in Catalogs are for reference purposes only, and do not guarantee that the product will always operate appropriately in that range.
- (3) The specifications / appearance and accessories of IDEC products listed in Catalogs are subject to change or termination of sales without notice, for improvement or other reasons.
- (4) The content of Catalogs is subject to change without notice.

2. Note on applications

- (1) If using IDEC products in combination with other products, confirm the applicable laws / regulations and standards.
Also, confirm that IDEC products are compatible with your systems, machines, devices, and the like by using under the actual conditions. IDEC shall bear no liability whatsoever regarding the compatibility with IDEC products.
- (2) The usage examples and application examples listed in Catalogs are for reference purposes only. Therefore, when introducing a product, confirm the performance and safety of the instruments, devices, and the like before use. Furthermore, regarding these examples, IDEC does not grant license to use IDEC products to you, and IDEC offers no warranties regarding the ownership of intellectual property rights or non-infringement upon the intellectual property rights of third parties.
- (3) When using IDEC products, be cautious when implementing the following.
 - i. Use of IDEC products with sufficient allowance for rating and performance
 - ii. Safety design, including redundant design and malfunction prevention design that prevents other danger and damage even in the event that an IDEC product fails
 - iii. Wiring and installation that ensures the IDEC product used in your system, machine, device, or the like can perform and function according to its specifications
- (4) Continuing to use an IDEC product even after the performance has deteriorated can result in abnormal heat, smoke, fires, and the like due to insulation deterioration or the like. Perform periodic maintenance for IDEC products and the systems, machines, devices, and the like in which they are used.
- (5) IDEC products are developed and manufactured as general-purpose products for general industrial products. They are not intended for use in the following applications, and in the event that you use an IDEC product for these applications, unless otherwise agreed upon between you and IDEC, IDEC shall provide no guarantees whatsoever regarding IDEC products.
 - i. Use in applications that require a high degree of safety, including nuclear power control equipment, transportation equipment (railroads / airplanes / ships / vehicles / vehicle instruments, etc.), equipment for use in outer space, elevating equipment, medical instruments, safety devices, or any other equipment, instruments, or the like that could endanger life or human health
 - ii. Use in applications that require a high degree of reliability, such as provision systems for gas / waterworks / electricity, etc., systems that operate continuously for 24 hours, and settlement systems
 - iii. Use in applications where the product may be handled or used deviating from the specifications or conditions / environment listed in the Catalogs, such as equipment used outdoors or applications in environments subject to chemical pollution or electromagnetic interference
If you would like to use IDEC products in the above applications, be sure to consult with an IDEC sales representative.

3. Inspections

We ask that you implement inspections for IDEC products you purchase without delay, as well as thoroughly keep in mind management/maintenance regarding handling of the product before and during the inspection.

4. Warranty

- (1) Warranty period
The warranty period for IDEC products shall be three (3) year after purchase or delivery to the specified location. However, this shall not apply in cases where there is a different specification in the Catalogs or there is another agreement in place between you and IDEC.
- (2) Warranty scope
Should a failure occur in an IDEC product during the above warranty period for reasons attributable to IDEC, then IDEC shall replace or repair that product, free of charge, at the purchase location / delivery location of the product, or an IDEC service base. However, failures caused by the following reasons shall be deemed outside the scope of this warranty.
 - i. The product was handled or used deviating from the conditions / environment listed in the Catalogs
 - ii. The failure was caused by reasons other than an IDEC product
 - iii. Modification or repair was performed by a party other than IDEC
 - iv. The failure was caused by a software program of a party other than IDEC
 - v. The product was used outside of its original purpose
 - vi. Replacement of maintenance parts, installation of accessories, or the like was not performed properly in accordance with the user's manual and Catalogs
 - vii. The failure could not have been predicted with the scientific and technical standards at the time when the product was shipped from IDEC
 - viii. The failure was due to other causes not attributable to IDEC (including cases of force majeure such as natural disasters and other disasters)
 Furthermore, the warranty described here refers to a warranty on the IDEC product as a unit, and damages induced by the failure of an IDEC product are excluded from this warranty.

5. Limitation of liability

The warranty listed in this Agreement is the full and complete warranty for IDEC products, and IDEC shall bear no liability whatsoever regarding special damages, indirect damages, incidental damages, or passive damages that occurred due to an IDEC product.

6. Service scope

The prices of IDEC products do not include the cost of services, such as dispatching technicians. Therefore, separate fees are required in the following cases.

- (1) Instructions for installation / adjustment and accompaniment at test operation (including creating application software and testing operation, etc.)
- (2) Maintenance inspections, adjustments, and repairs
- (3) Technical instructions and technical training
- (4) Product tests or inspections specified by you

The above content assumes transactions and usage within your region. Please consult with an IDEC sales representative regarding transactions and usage outside of your region. Also, IDEC provides no guarantees whatsoever regarding IDEC products sold outside your region.

IDEC CORPORATION

Head Office 6-64, Nishi-Miyahara-2-Chome, Yodogawa-ku, Osaka 532-0004, Japan

USA IDEC Corporation
EMEA APEM SAS

Singapore IDEC Izumi Asia Pte. Ltd.
Thailand IDEC Asia (Thailand) Co., Ltd.
India IDEC Controls India Private Ltd.

China IDEC (Shanghai) Corporation
IDEC Izumi (H.K.) Co., Ltd.
Taiwan IDEC Taiwan Corporation

Japan IDEC Corporation

 www.idec.com